

TMS 2020 Club Project 1/4" scale pattern

Note: Patterns with labels/dimensions were scaled from full size - so the measurements do not apply. 1" thick = 1/4" thick, not 1 inch in quarter scale :)

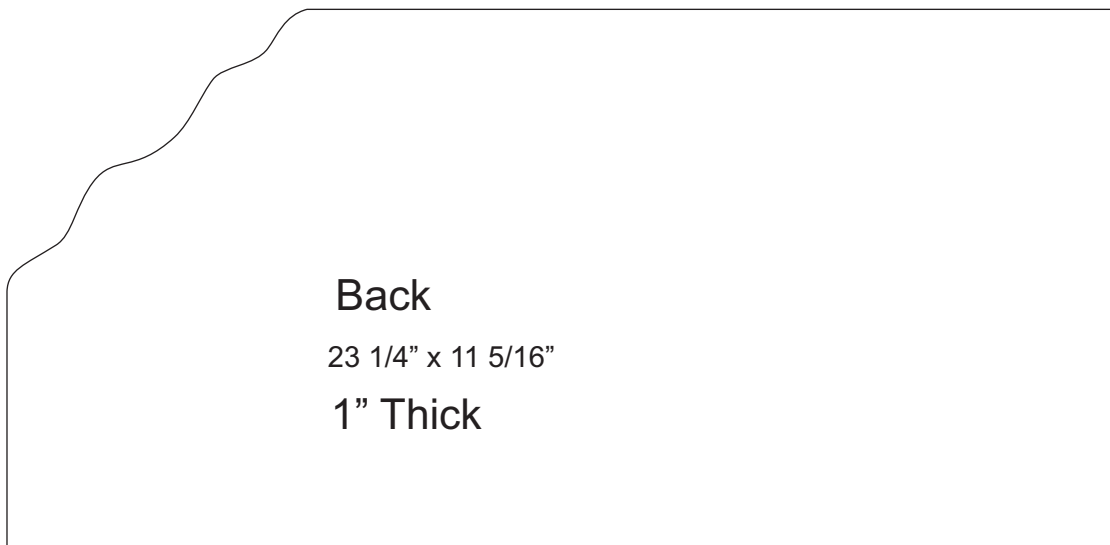
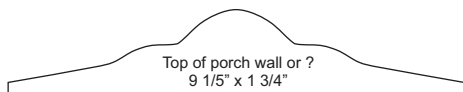
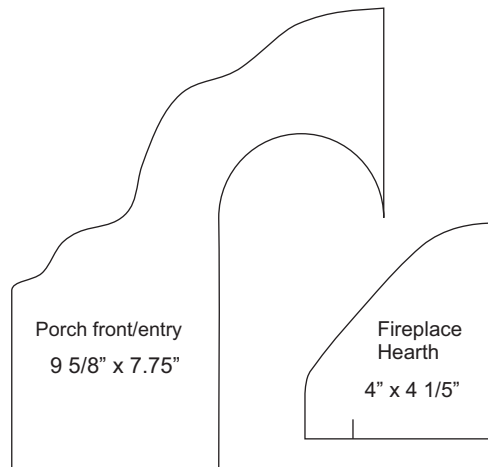
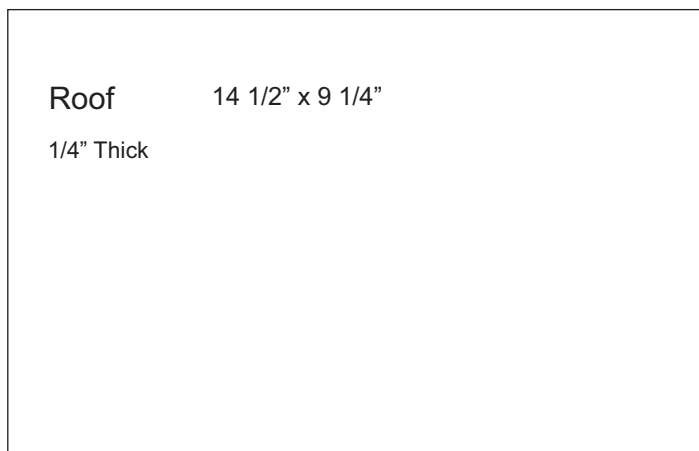
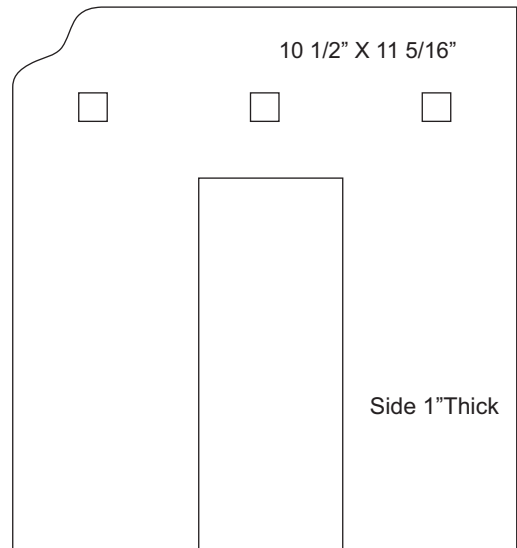
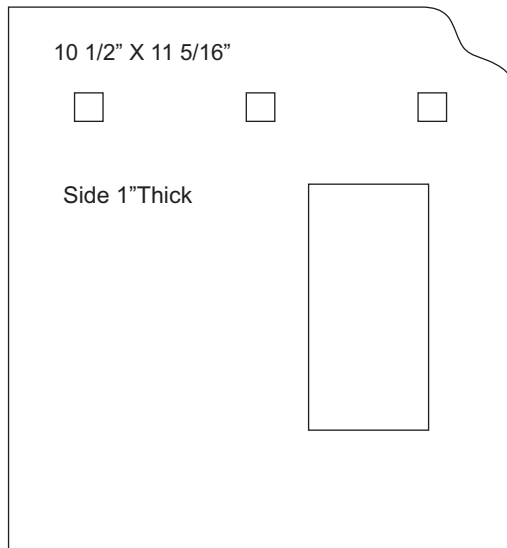
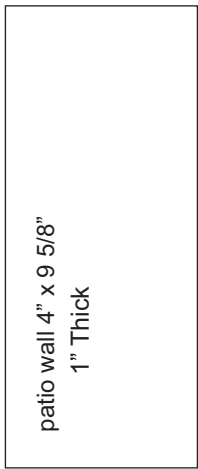

Original pattern also included a rectangle 1" x 11 1/2 inches with no markings on it. It was not used in the prototype, Sallie did not know what it was for.